

ojačitve v osi E-B

ojačitve v osi E-A

ojačitve v osi D-B

ojačitve v osi D-A

ojačitve v osi B-A

ojačitve v osi B-B

Jašek osi A - pogled:

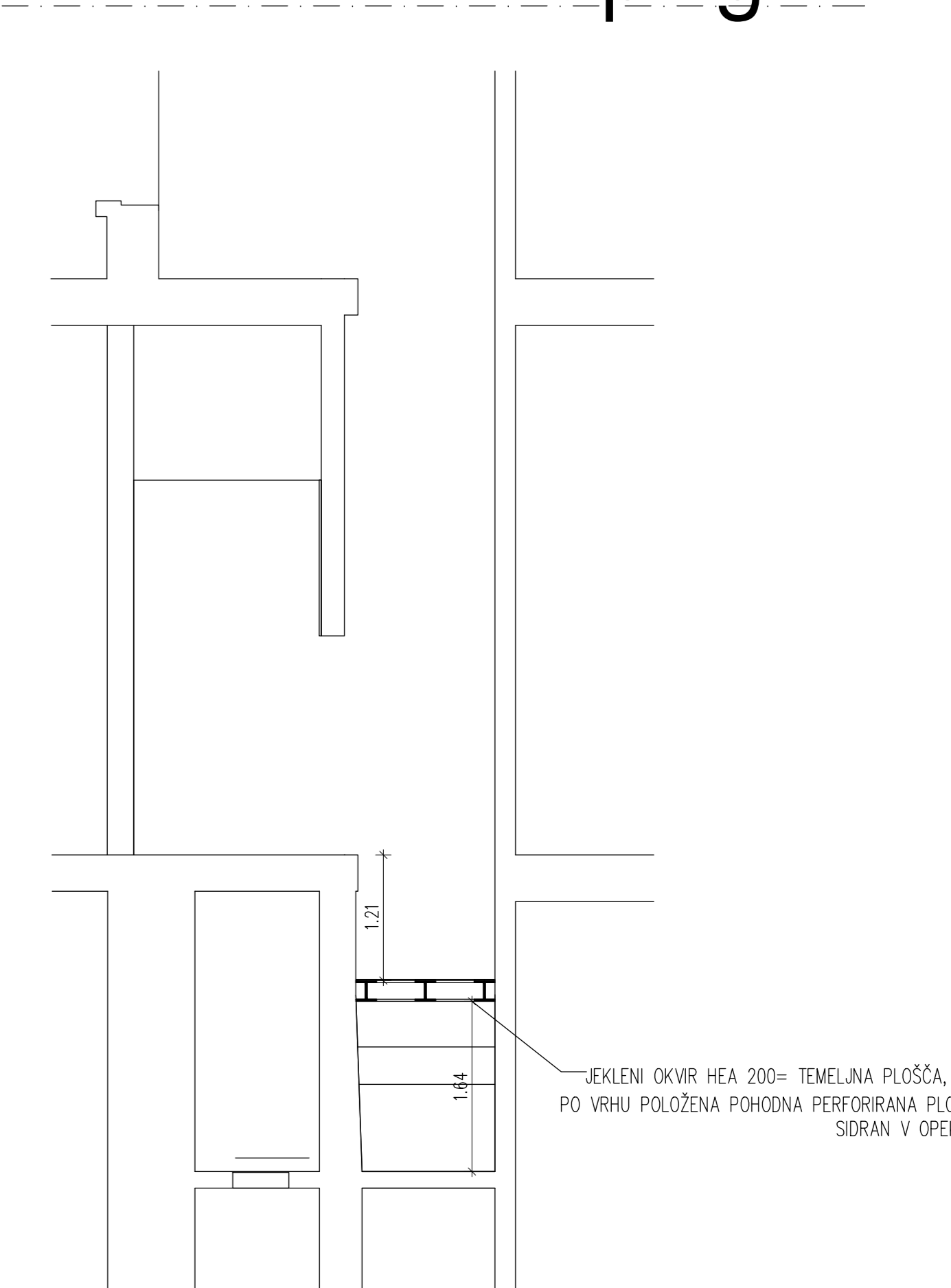
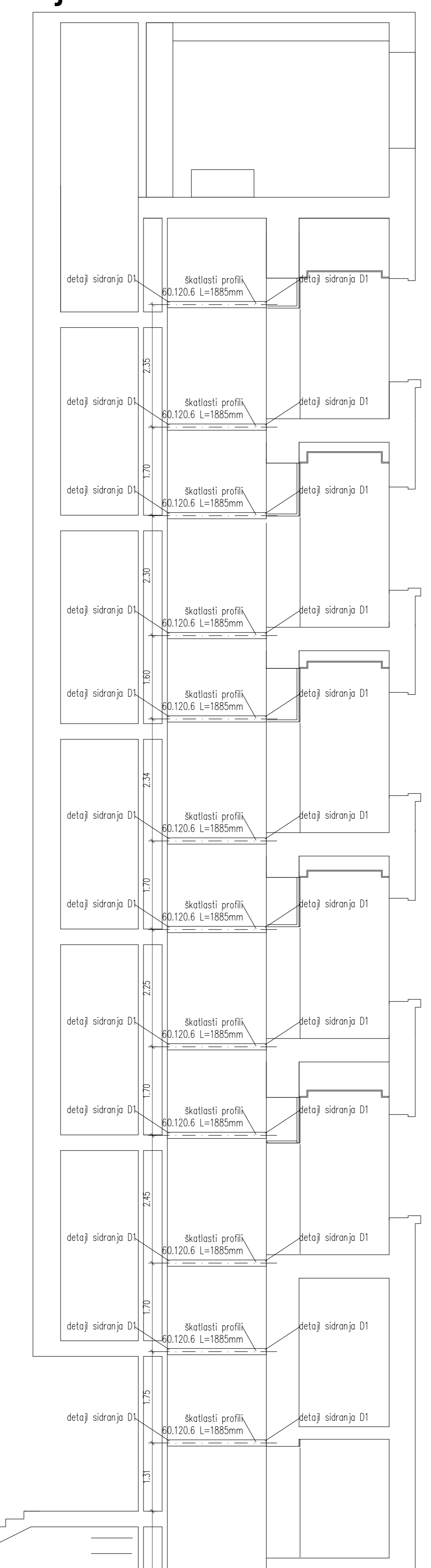
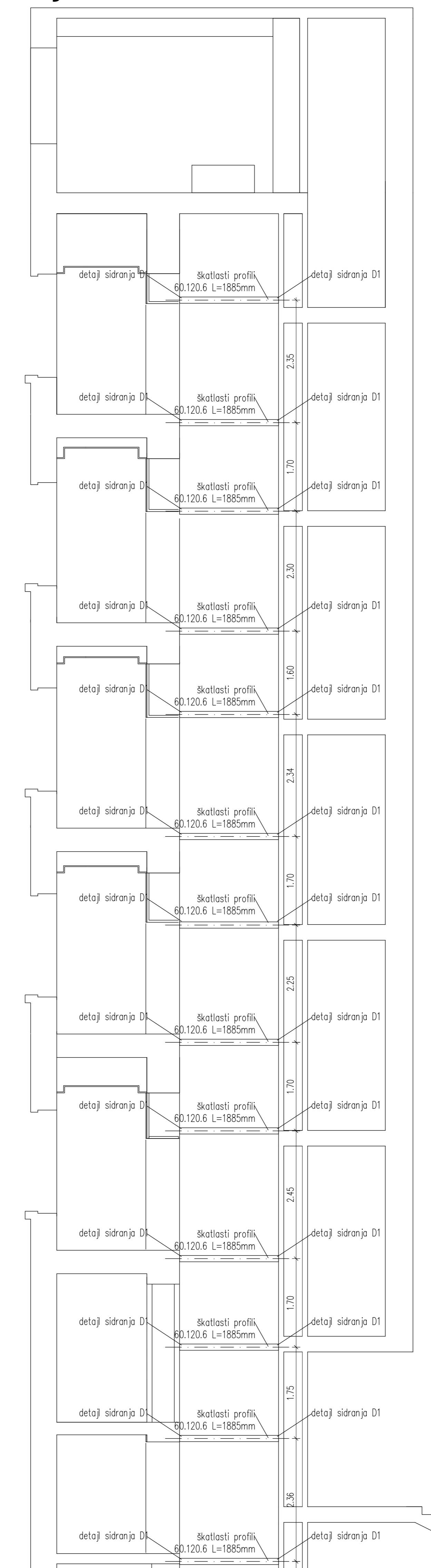
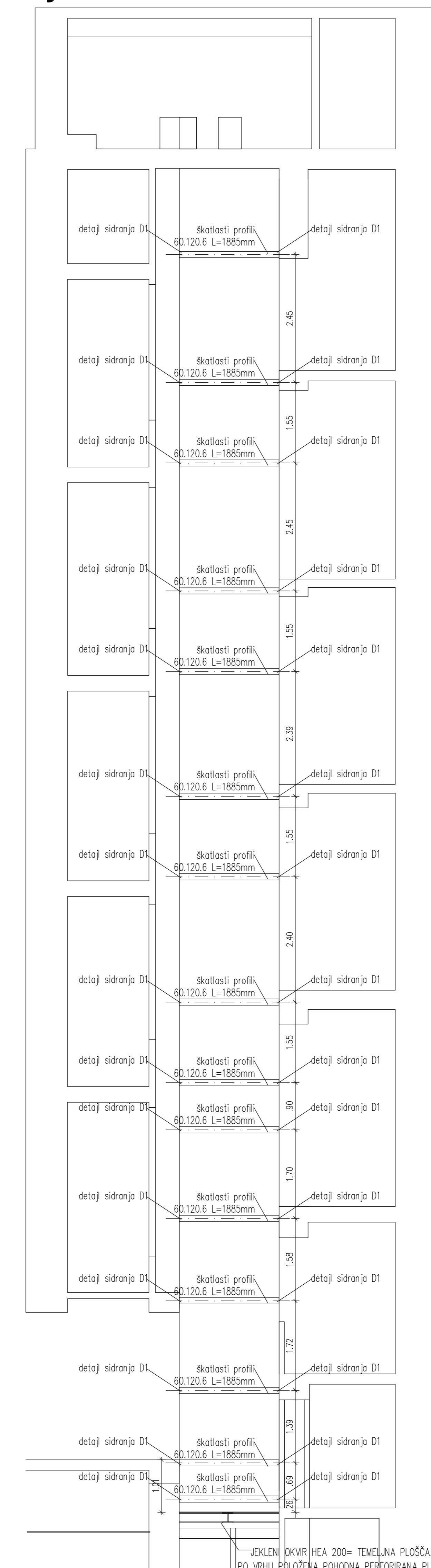
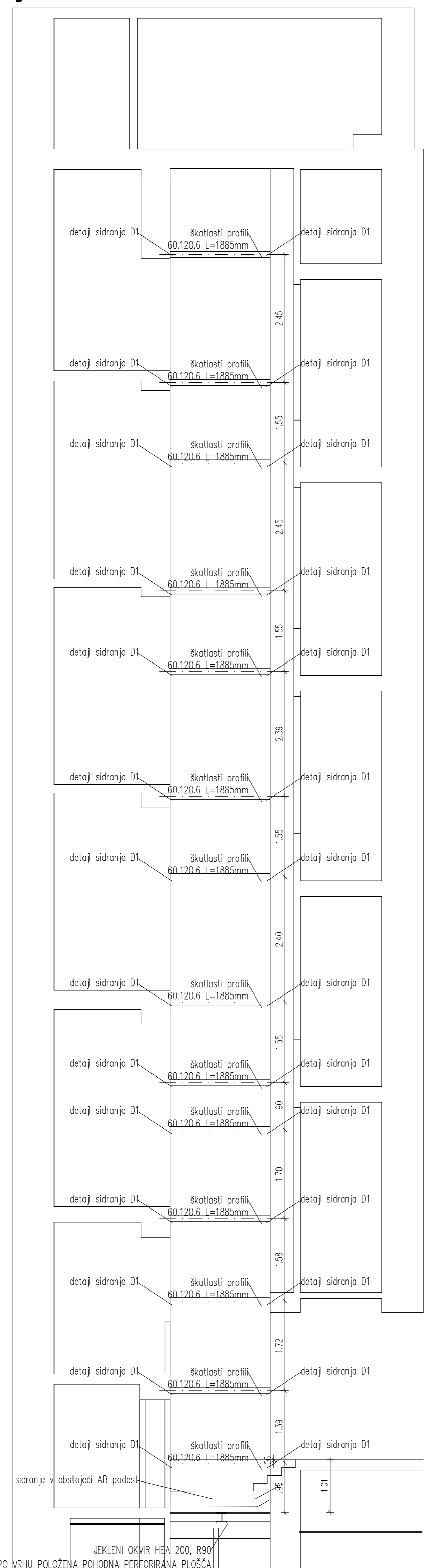
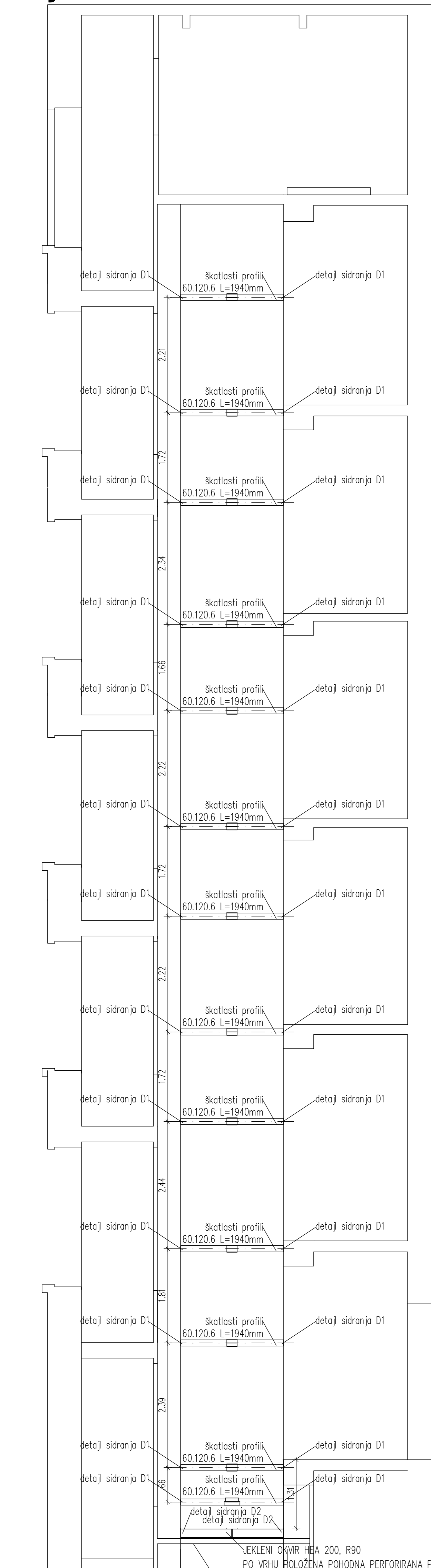
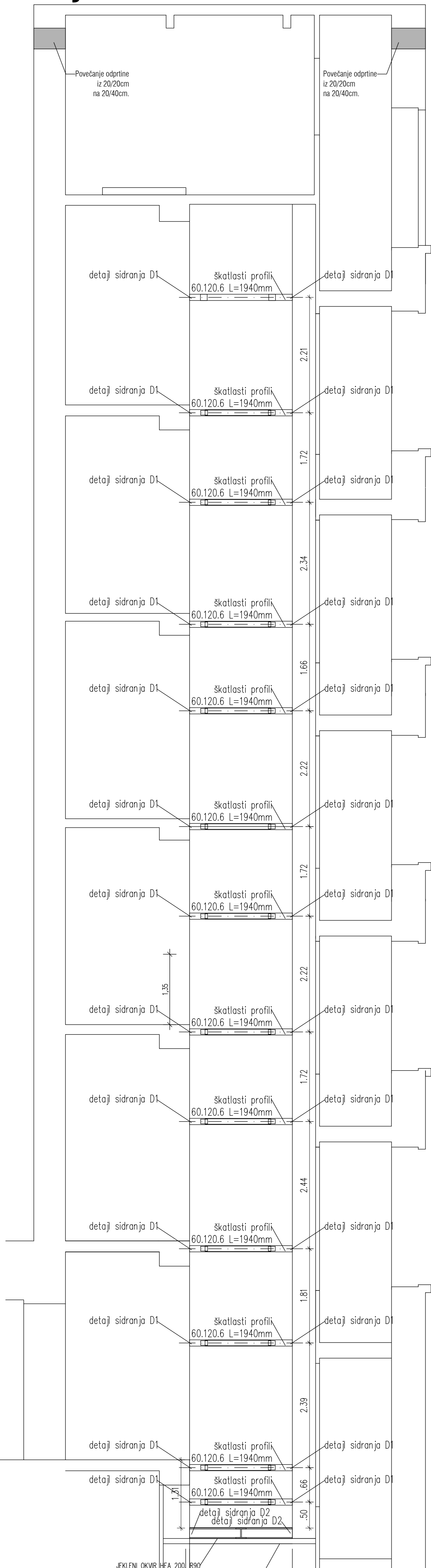

Jašek osi A - tloris: ojačitve na dnu jaška-tloris

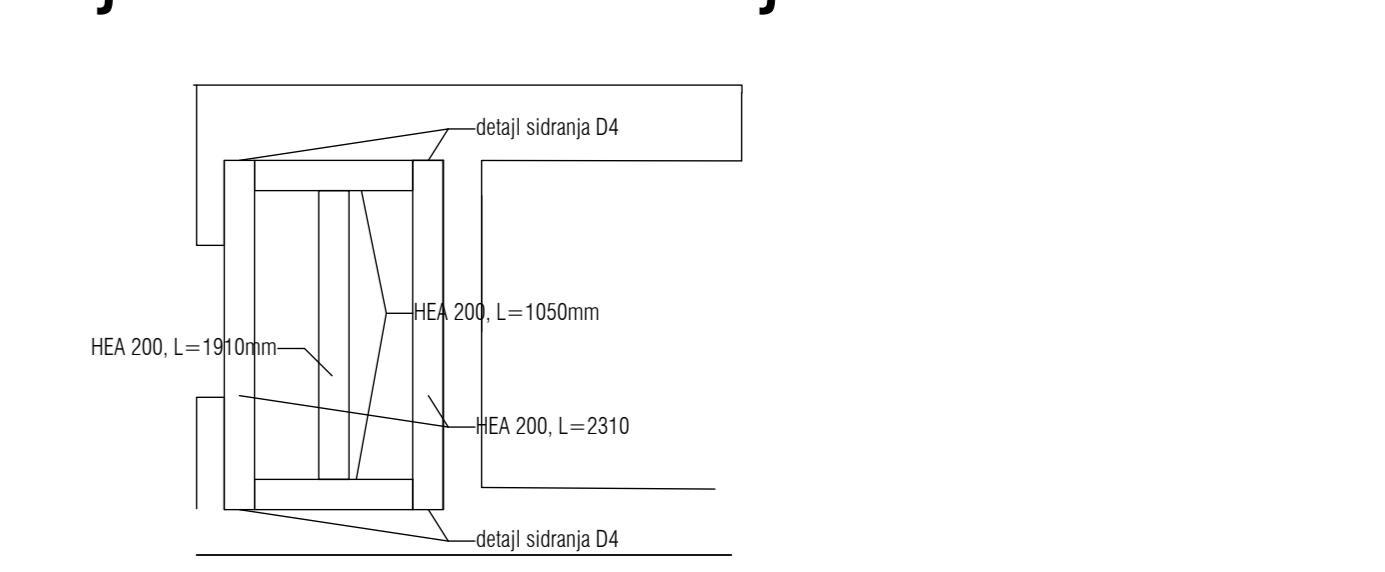

Jašek osi C - pogled:

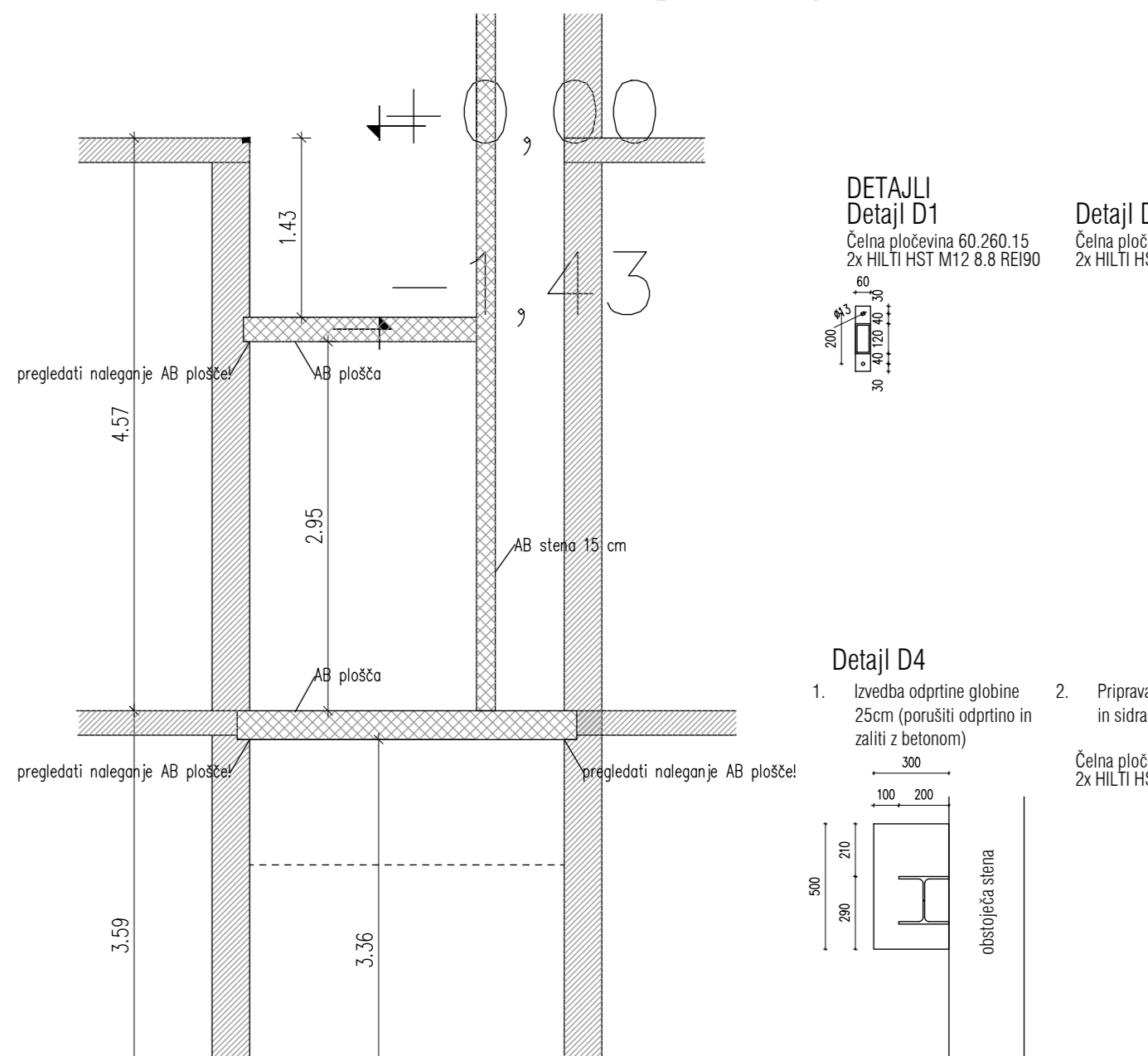

Jašek osi C - tloris:

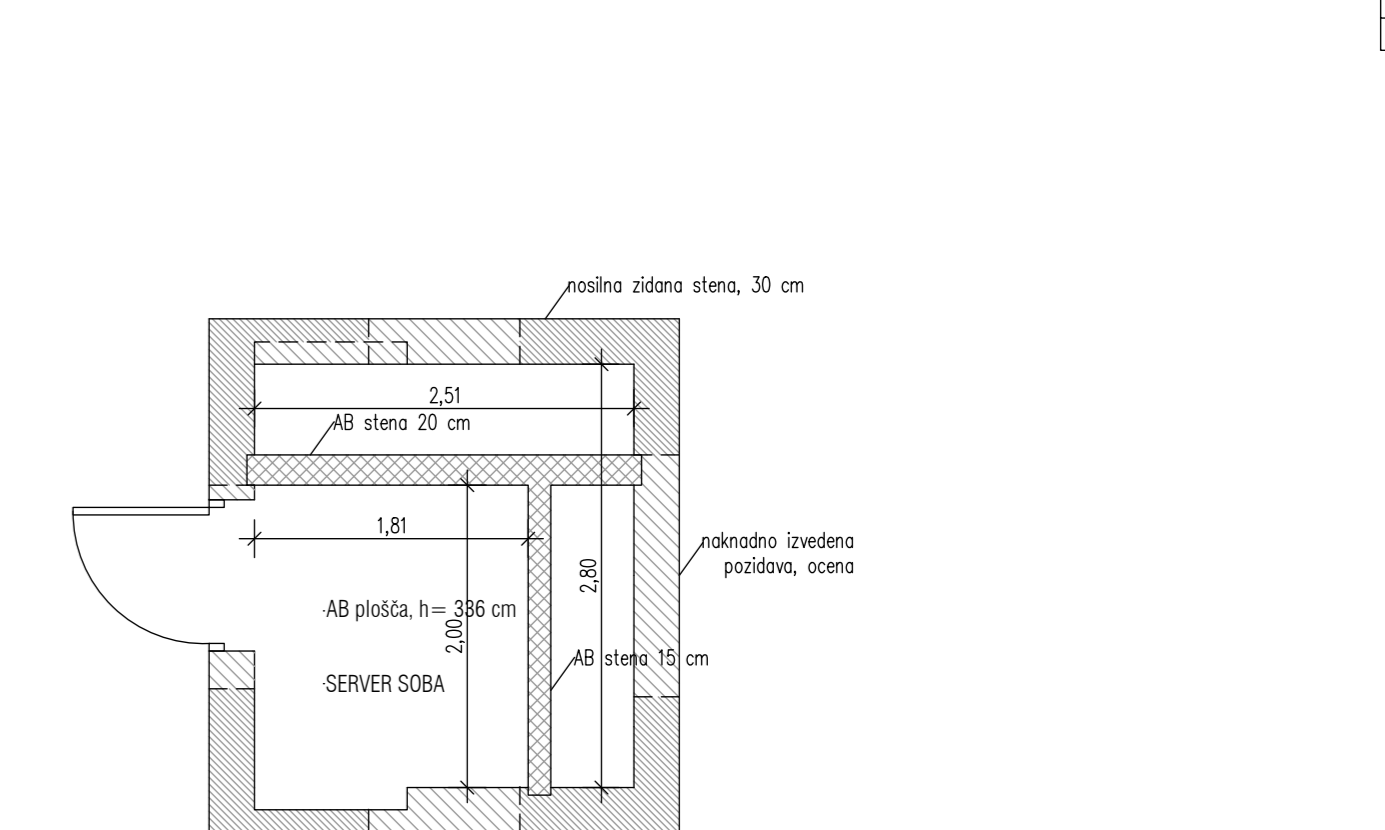

Jašek osi E - tloris: etažne ojačitve-tloris

ojačitve na dnu jaška-tloris

Jašek osi D - tloris: etažne ojačitve-tloris

ojačitve na dnu jaška-tloris

Jašek osi B - tloris: etažne ojačitve-tloris

ojačitve na dnu jaška-tloris

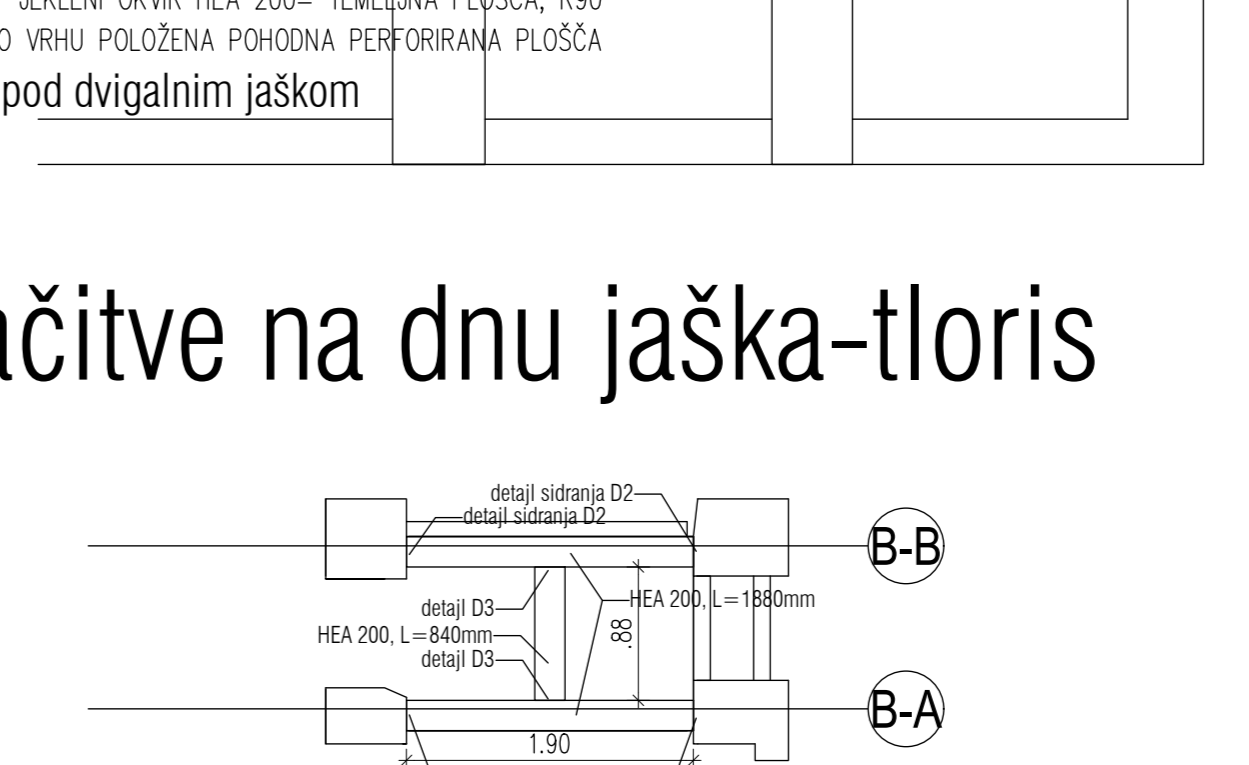
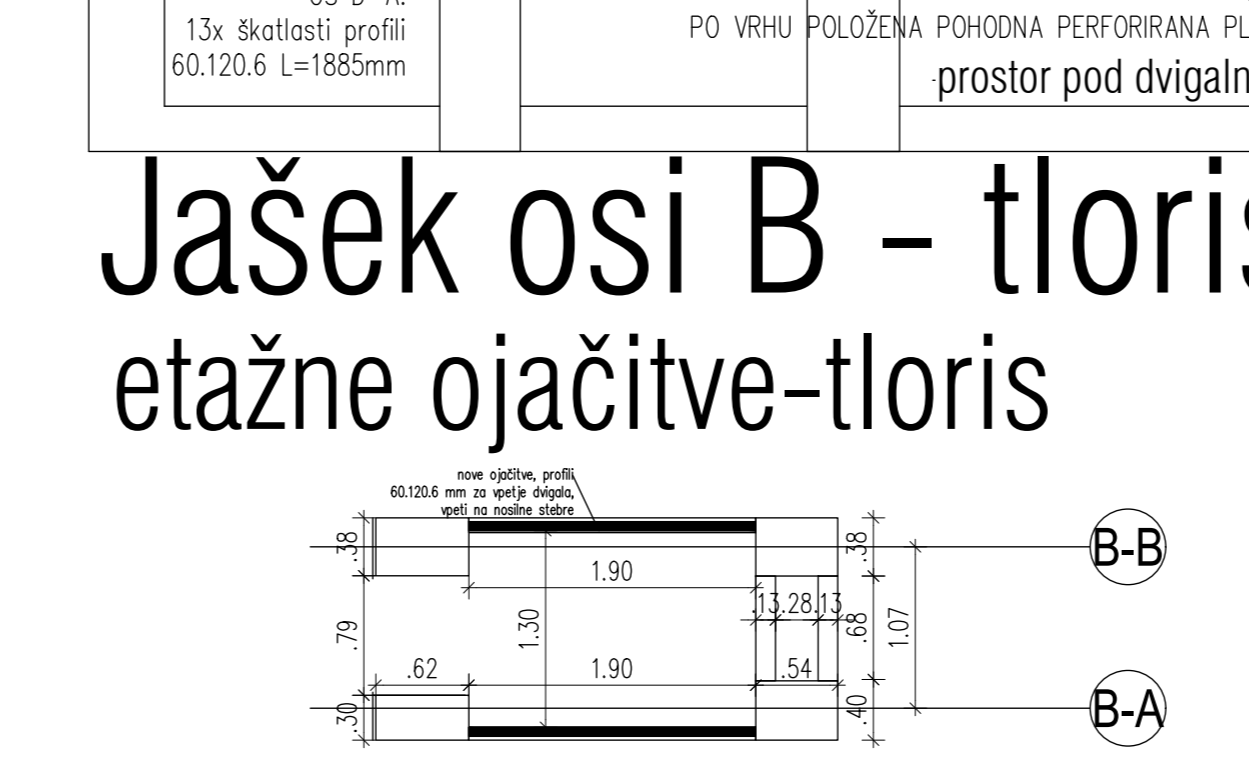
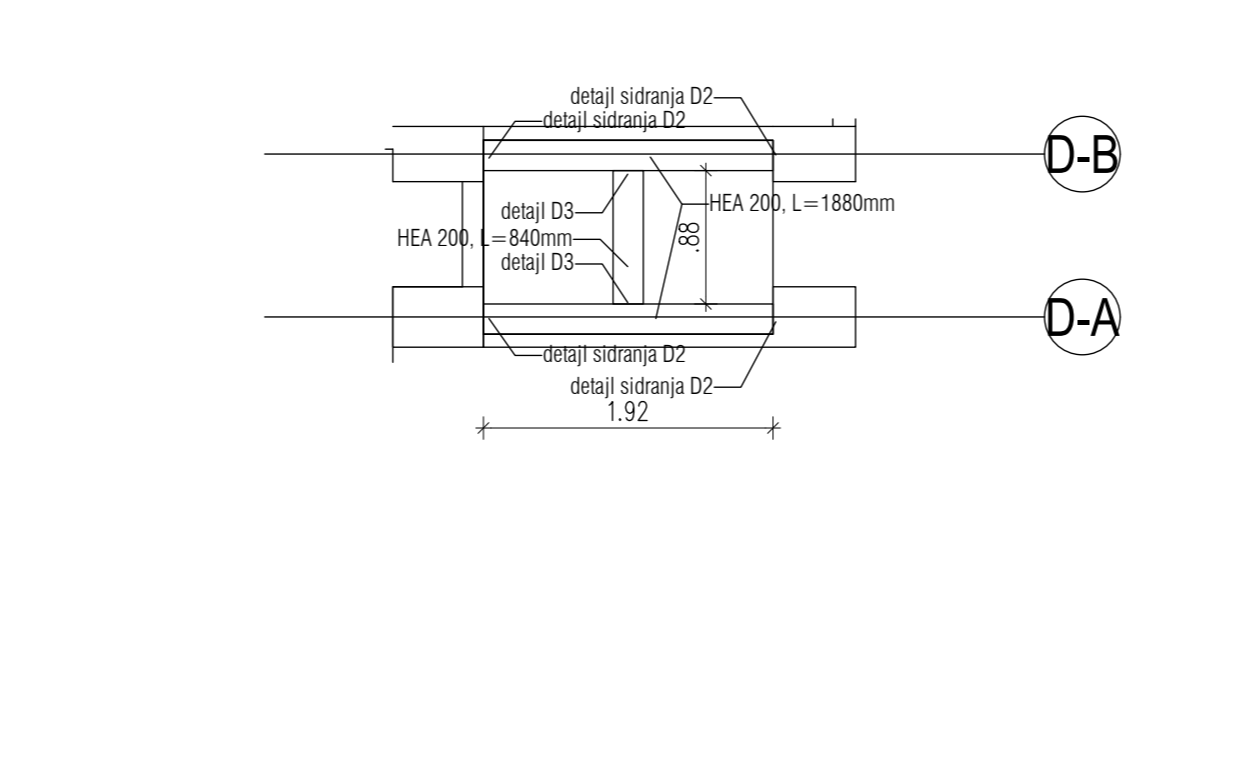
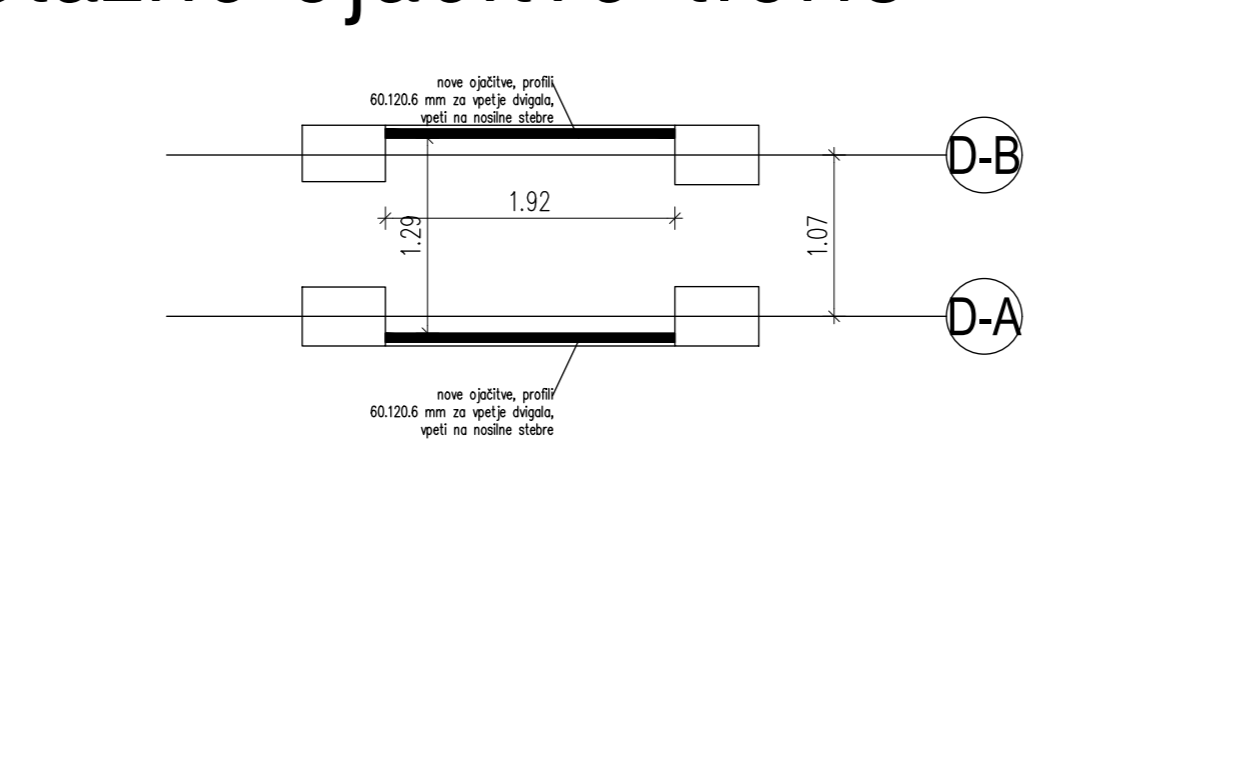
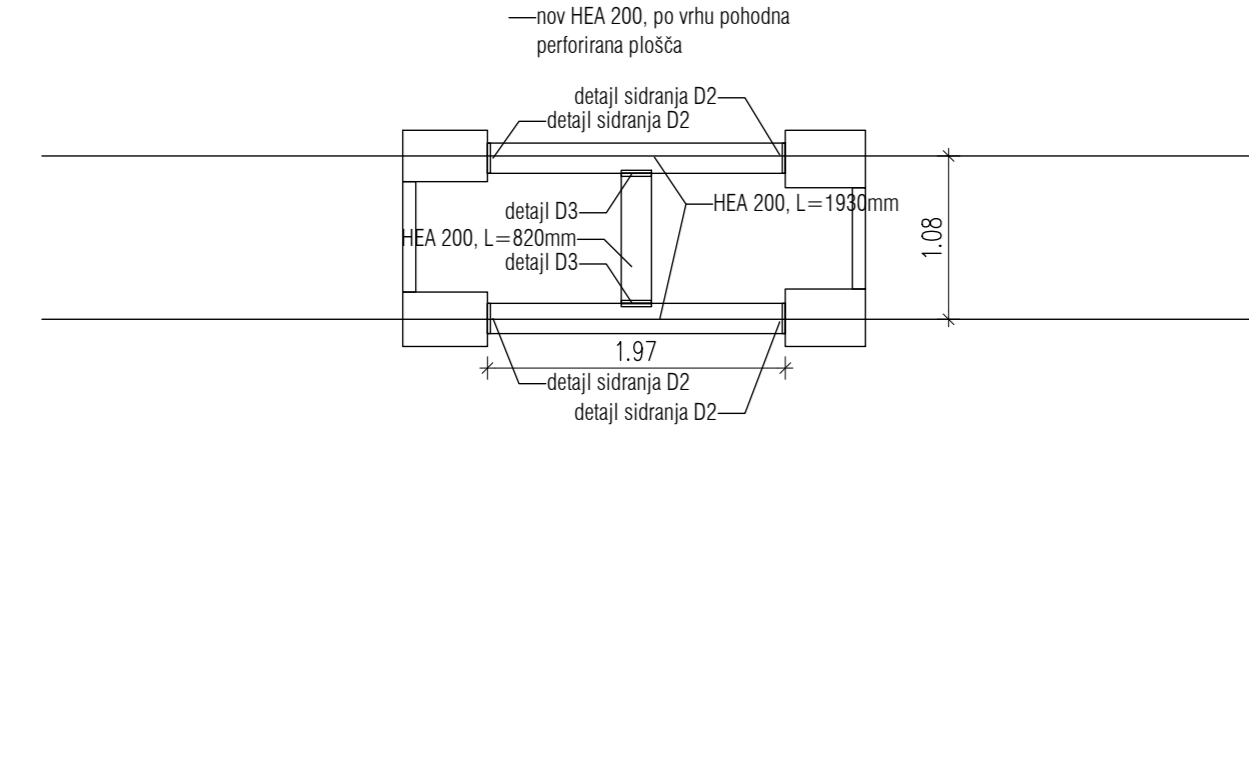
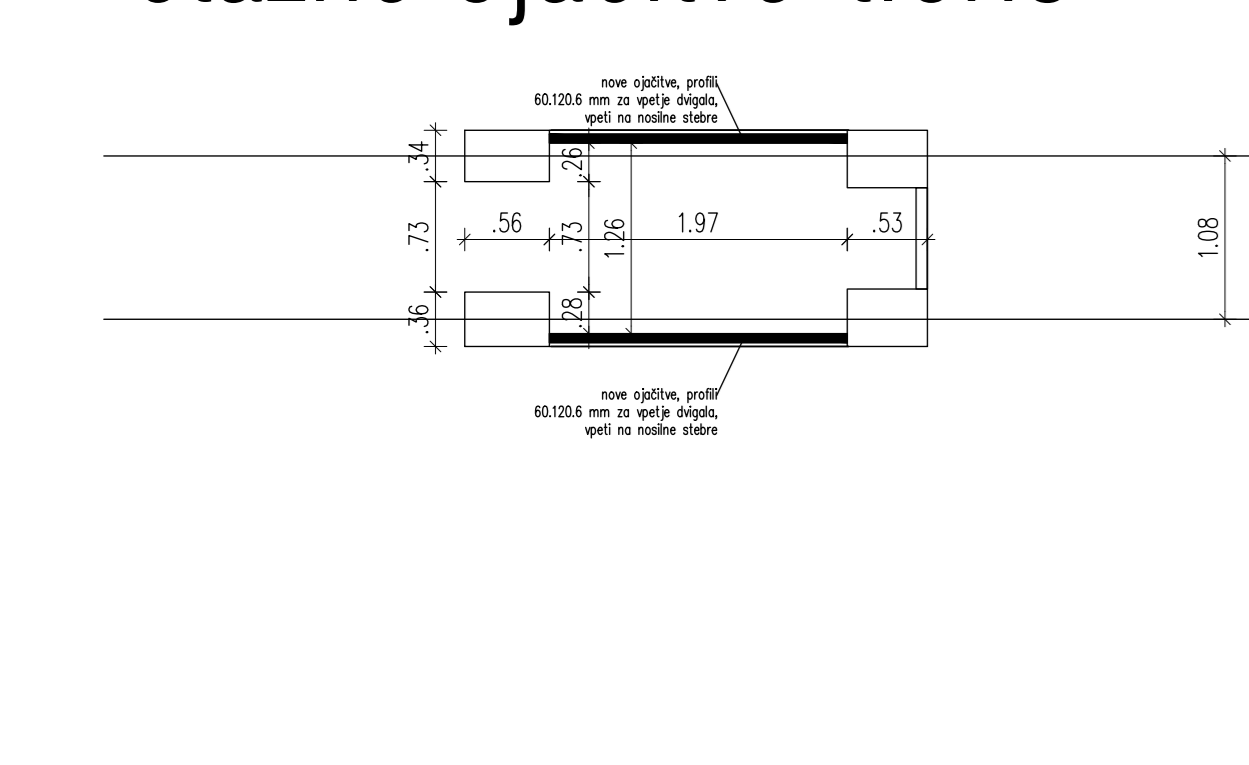

PODZU ZA UPORABO VGRADNINARSKIH/TOKOVNIH ELEMENTOV		SESTAVA		SESTAVA	
NO	Opis	Šifra	Opis	Šifra	Opis
1	Skalasti profil	60.120.6	L=1940mm	13x	Skalasti profil
2	Detalj sidranja D1				
3	Detalj sidranja D2				
4	Detalj sidranja D3				
5	Detalj sidranja D4				